



Precautions for use

Pressure	35
Speed	35
Environmental conditions	35
Mounting	36
Piping	37
Other notes	37
Operation	37
Maintenance	39
Storage	39
Disposal	39

Use cylinders only under the operating conditions within the allowable range specified for each series. Otherwise, the performance may become unreliable as described below, or accidents may occur.

1. Pressure

The pressure supplied to cylinders, including surge pressure, must be lower than the maximum allowable level. The use with the pressure exceeding the maximum allowable level may lead to galling in the slipping part or the damaged cylinder.

2. Speed

Use cylinders within the allowable working speed range. Otherwise, troubles below may occur.

When cylinders are used with the speed slower than the lower limit of the working speed range:

- Stick slip (cracks)
- Unsmooth speed control

When cylinders are used with the speed faster than the upper limit of the working speed range:

- Damaged cylinder due to increased kinetic energy
- Damaged packings due to slipping heat
- Increased internal or external oil leak due to thickened oil film
- Higher flow velocity in the piping part, causing the lowered energy efficiency due to increased pressure loss

3. Environmental conditions

3-1) Temperature

Use cylinders only within the allowable working temperature range. Otherwise, troubles below may occur.

When cylinders are used at the temperature lower than the lower limit of the working temperature range:

- Brittle fracture due to lowered stretch of cylinder material
- Oil leak due to lowered elasticity of packings

When cylinders are used at the temperature higher than the upper limit of the working temperature range:

- Damage due to lowered strength of cylinder material
- Damaged packings
- Galling due to thermal expansion in the slipping part

For the use of the items below, use them at the temperature lower than the upper limits shown below.

Items		Upper limit oil temperature
Switch set cylinder	WR · WS types	60°C or lower
	Other switches	70°C or lower
Cylinder with position detector	35P-3 70/140P-8	50°C or lower
	70 · 140MT-3	65°C or lower
Cylinder with primary components for which aluminum alloy is used (35S-1 · 100S(W)-1 · 35SY-1)		70°C or lower

If several items with different upper limits of oil temperature are used, adopt the lowest temperature limit, and use the items at the temperature lower than the adopted upper limit.

Ex.) When using 100SW-1R with the WR type switch, use it at 60°C or lower.

3-2) Rust-proof measures

The use and storage of cylinders in the places where are highly humid, or are splashed with water or sea water require the consideration of rust-proof and anti-corrosion measures. In such a case, contact us.

3-3) Installing location

(1) Use cylinders only indoors.

(2) Avoid the use in the places where are subjected to dusts and vibrations.

DO NOT use them under the environmental conditions shown below. The use under these conditions requires the protection of the rod part, rust-proof measures, review of part material, magnetic shield, and vibration-proof measures. If any countermeasure required for the cylinder side, contact us.

Working environmental conditions

Sands, dusts, soil, chips, welder spatter, etc.

Rain, water, sea water, oil, chemicals, etc.

Direct sunlight (ozone), humidity, etc.

High temperature, low temperature, freezing, etc.

Highly magnetic field

Vibrations

4. Mounting

⚠ CAUTION

- For the mounting of cylinders, use bolts of the specified size, and fix with the bolts of the strength class (refer to JIS B8367).
In the case of the rotary type, use pins of the specified size. Otherwise, screws may be loosened or damaged due to cylinder driving force or its reaction force.
- When a cylinder is mounted with fixed, the performance of the cylinder largely depends on the hardness of the mounting material. Therefore, insufficient hardness of mounting material may lead to a warp in mounting material due to the driving force of the cylinder and the disordered piston rod and bush, causing premature wear and the damaged thread of the piston rod. Use the mounting material with sufficient hardness.

4-1) Mounting of rod end in the case of fixed type

(SD, EA, EB, LA, LB, FA, FB, FY, FE, FZ, FC, FD types)
The movement direction of articles moved by a cylinder must be always aligned with the axis center of the piston rod movement. If the axis center is runout, premature wear of the bush, baking or galling of the cylinder tube may occur. To check the runout of the axis center, be sure to measure the core deviation of mounting part of the article at the position where the piston rod is fully ejected, and align the core. Then, connect the cylinder with the article.

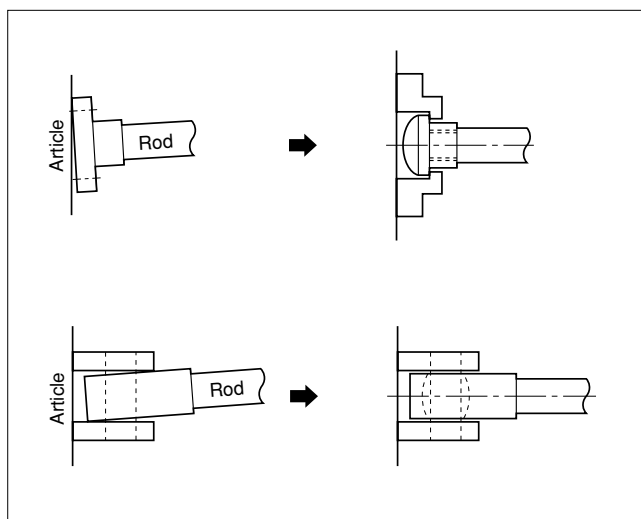

4-2) Mounting of cylinder

When mounting cylinders, consider the following points. We cannot take responsibility for malfunctions due to wrong cylinder mounting.

(1) In the case of fixed type

- ① SD type
 - Thread accuracy of tie rod : JIS 6h (equivalent to JIS grade 2)
 - Clamping torque : tie rod clamping specified torque value (Refer to the clamping torque for each series.)

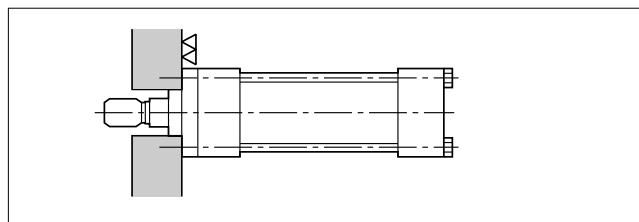

② LA, LB and LC types

To mount LA and LB types, fix the attachments with clamping bolts. However, remember that this procedure is not perfect for the move in the axial direction when a load is applied. Therefore, install the stopper to the mounting base, as shown in the figures below.

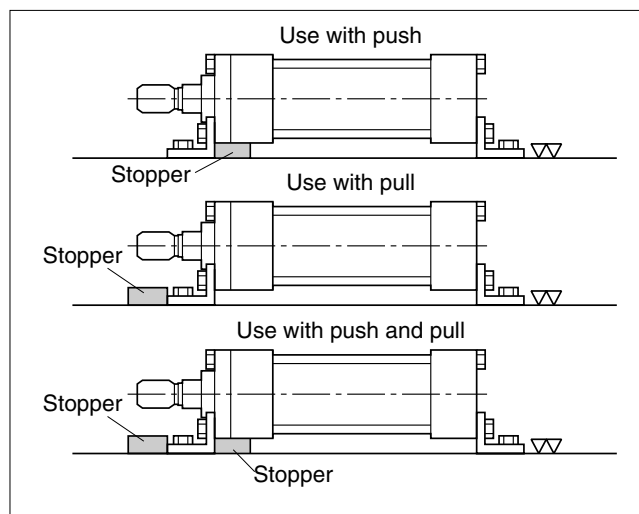

③ EA, EB, FA, FB, FY, FE, FZ, FC, and FD types
Fix cylinders as shown in the figures below.

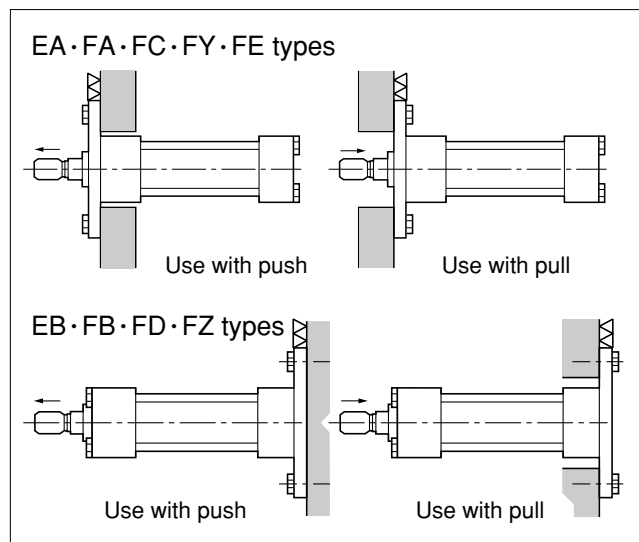

(2) Rotary type

- For the cylinder of which mounting part moves inside a plane, be sure to connect the connection fittings of the rod end with pins, so that the mounting part can move inside the plane. For the plane and rectangular direction, perform centering similarly to the fixed type.
- Be sure to apply lubricant to the bearing part of the connection fittings.
- DO NOT use floating joints for rod end attachments.

① CA, CB type attachments

- Use pins of the size specified in this catalogue.
- In the case of a long stroke (1000 mm or longer), avoid horizontal mounting. Otherwise, a lateral load is applied to the bush part due to the weight of the cylinder, causing uneven abrasion, substantially shorter service life, or galling.

② TA, TC type attachments

Mount counterpart attachments so that they are vertical with the trunnion boss. If they are mounted slantingly, uneven abrasion may occur in the boss bearing area, causing a substantially shorter service life.

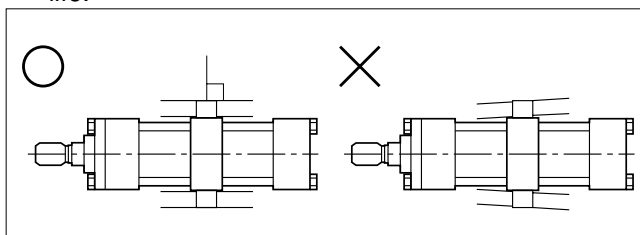

5. Piping

- Take sufficient care to avoid dusts and chips of pipes in the piping.
- When piping, avoid any air accumulation in pipes.
- When connecting with a rubber hose, do not bend it with the bending radius smaller than the specified level.
- Be sure to perform piping flushing. After flushing is complete, connect to the cylinder. Otherwise, the cylinder may be malfunctioned or oil leak may occur due to dusts in the piping.

6. Other notes

- When welding near a cylinder, it may be subjected with spatters. Protect the cylinder rod to avoid spatters.
- When welding during mounting, take sufficient care to avoid an electric current in the cylinder. Any electric current in the cylinder may lead to arcs between the rod and bush or between the piston and tube, causing the damaged cylinder parts.
- After mounting is complete, be sure to perform air vent and cushion adjustment. For the adjustment methods, follow the descriptions in "7. Operation".

7. Operation

⚠ CAUTION

- If the piston speed is fast from the beginning, abnormal surge pressure may occur, causing the damaged cylinder or machine.

• Trial run (before operation)

7-1) Air vent

⚠ CAUTION

Overloosening of the check valve during the air vent may lead to the coming-off of the check valve from the cylinder, causing spouted oil and serious accidents.

- (1) Feed oil of low pressure (the pressure that the cylinder moves at a low speed, approx. 10 mm/s) to the cylinder, and vent air in oil from the check valve or air vent plug.

- At this time, if the check valve is excessively loosened, it may be come off from the cylinder, causing spouted oil and serious accidents.
- Repeat the step above until no air remains in the pipe.
- Exhaust air in the piping, as well as that in the cylinder. Any air remained may cause malfunctions below.

[Symptoms]

- a) Stick slip
- b) Unsmooth speed control
- c) Damaged packings due to increased temperature caused by adiabatic compression
- d) Shock or vibration occurs to outside
- e) Impossibility of set output

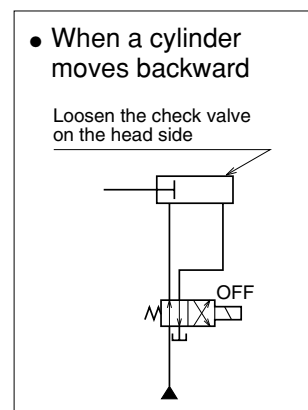
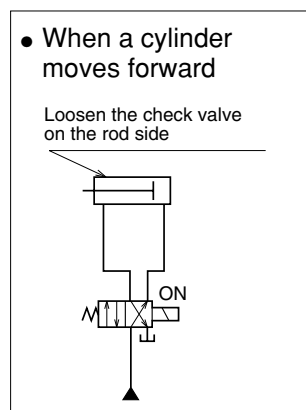

- (2) After air vent procedure is complete, clamp the check valve or air vent valve (clamping torque: 8 to 10 N·m), and check for oil leak.

7-2) Adjustment of cushion valve

CAUTION

Even if the cushion valve is loosened during the cushion adjustment, it touches the cushion plug to prevent it from being removed. However, if it is forcibly turned, it may be loosened and oil may be spouted, causing serious accidents.

(Cylinder with cushion)

Increase the piston speed gradually from a low speed, 50 mm/s or lower, and adjust the cushion.

- The cushion must be adjusted, since it has not been adjusted at our factory.
- If the piston speed is fast from the beginning, abnormal surge pressure may occur, causing the damaged cylinder or machine.
- Even if the cushion valve is loosened during the cushion adjustment, it touches the cushion plug to prevent it from being removed. However, if it is further loosened, oil may be spouted, causing serious accidents.

Diagram of cushion valve structure

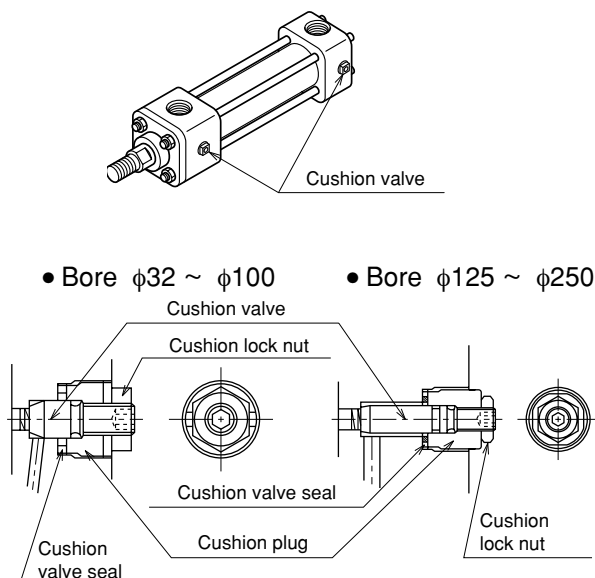

- (1) Perform the adjustment of the cushion valve by following the sequences below.

- ① Loosen the cushion lock nut with a spanner.
Note) DO NOT loosen the cushion plug.

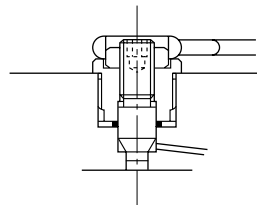

- ② Turn the cushion valve only with an allen wrench.
- Turn clockwise: the cushion stroke speed decreases.
 - Turn counterclockwise: the cushion stroke speed increases.

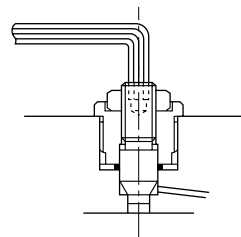

- The structure of cushioning, built in the cylinder, is equipped to prevent it from being damaged. For the inertia force that cannot be absorbed with the structure of cushioning, install the inertia force absorber or measurers in the hydraulic circuit.

- ③ After the adjustment of the cushion valve is complete, fix the cushion valve with an allen wrench, and clamp the cushion lock nut. (clamping torque: 7 to 8 N·m)

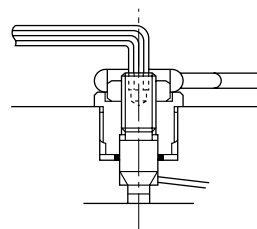

- Note) • Cushion lock nut must not be fasten to excess. Otherwise cushion valve will be damaged.

8. Maintenance (maintenance and inspection)

To use cylinders without an accident for a long time, daily and regular inspections are required.

1) Daily inspection

For the daily inspection, check the points described below.

- (1) Check that the cylinder set bolts and nuts are not loosened.
- (2) Check that the working conditions are normal.
- (3) Check that there is no external leakage.
- (4) Check that there is no abnormality in other parts of the cylinder (tie rod, flange, etc.)

2) Regular inspection (disassembly inspection)

Decide the interval of the regular inspection depending on the working conditions and requirement, and perform according to the decided schedule. It is recommended to perform it once a year.

- Replace packings and gaskets with fresh ones at regular inspections.
- Do not use packings which have been stored for two years or more.
- Notes on fitting of valve seals

Valve seals must be fit in the specified direction and sequence. Wrong fitting direction and sequence will lead to the damaged packings, causing oil leak.

Fitting sequences

- ① Check the direction of a valve seal.
The marked side must be faced inside (refer to Fig.1).
- ② Fit the valve seal to the shaft of the cushion valve and the shaft of the check plug in the correct fitting direction (refer to Fig.2).
- ③ Take care to prevent the valve seal from being dropped, and screw it in (refer to Fig.3).

Fig.1

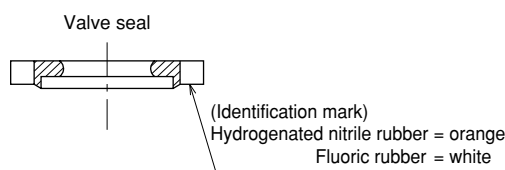

Fit with the marked side facing inside of the cylinder.

Fig.2

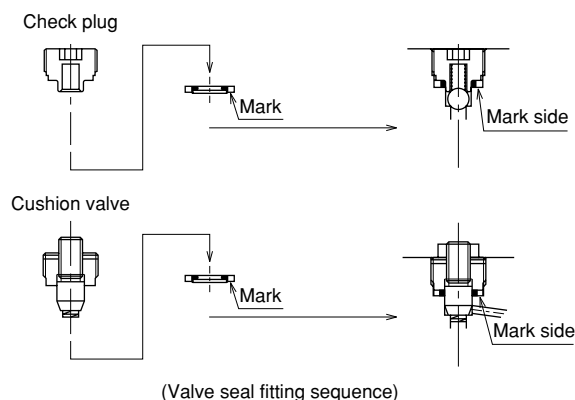

Note If the seal is first fit in the cover hole, and then, it is screwed in, it may be damaged.

9. Storage

1) Notes on storage

When storing cylinders, take countermeasures against the followings:

- (1) Rusts
- (2) Permanent warp and inferiority of packings

2) Storage location

- (1) Store cylinders in cool and dark place (max. temperature: 37°C), and protect them from direct sunlight and humidity. Place them higher than 30 cm from the floor.
- (2) DO NOT apply vibrations or shocks to the stored cylinders. The cylinder parts may be damaged.

3) Control and inspection during storage

- (1) Pack working oil (including rust preventive oil) in cylinders, and plug the port part.
 - If the port part is unplugged during storage, change working oil with fresh one, and plug again. Failure to perform this step may cause rusts on tube inside.
- (2) It is recommended to turn the stored cylinder 90°C every three months to let packed oil flow and reduce permanent warp of packings.
 - If there is any abnormality in the working condition of the cylinder that has been stored for a long time, replace packings.
 - If the storage period is a year or longer, it is recommended to perform the internal inspection of the stored cylinder.
- (3) Repeat of rust preventive treatment
After the purchase of cylinders, repeat rust preventive treatment every year.

- Internal rust-proof measures (rust-proof measures for cylinder inside)
Change working oil (including rust preventive oil) in the cylinder.
- External rust-proof measures (for machined face, exposed part)
Apply rust preventive oil to mounting faces to machines and machined faces, such as a rod end screw part. Also, apply grease to the rod slipping part and the dust seal part, and protect with oil paper.

10. Disposal

- 1) Disassemble cylinders, sort the disassembled components by material (iron, copper, aluminum, resin, rubber, waste oil, etc.), and then, dispose them.
- 2) Piston rods are hard chrome plated. When disposing them, consult with a disposal company.
- 3) Dispose resin base and rubber base components as nonflammable wastes.
- 4) When disposing waste oil, conform to related laws and rules.